



Rectangular duct fans

Caissons de ventilation pour gaines rectangulaires

Rechteckige Kanalventilatoren

Прямоугольные каналные вентиляторы



Rectangular ducts fans for ventilation and air conditioning systems, mounted into a system of rectangular air ducts. Used for the air supply or extract. Not suitable for polluted air, aggressive and explosive gases. Compact, mounted in any position. Easily opened doors for cleaning an impeller.

Impeller with backward curved blades, made of plastic or galvanized steel.

Motor: external rotor, motor protection with built-in thermal-contact, maintenance free ball bearings.

Housing: made of galvanized steel.



Rechteckige Kanalventilatoren, die für Lüftungs- und Klimaanlagen bestimmt sind, werden in das System der rechteckigen Luftführungs Kanäle montiert. Sie werden für Zuluft und Abluft verwendet. Nicht geeignet für die Beförderung von verschmutzter Luft, aggressiven, explosiven Gasen. Kompakt, leise funktionierend, Montage in jeder beliebigen Stellung, das Flügelwerk ist leicht zur Reinigung herausnehmbar.

Laufgrad ist rückwärts gekrümmt, aus Kunststoff bzw. verzinktem Stahl.

Der Motor: Außenrotor, Direktantrieb, integrierter Thermokontakt-Motorschutz, dauerhafte, keine Pflege erfordernde Lager.

Das Gehäuse: aus verzinktem Blech.



Les caissons de ventilation pour gaines rectangulaires sont destinés aux systèmes de ventilation et de climatisation utilisant des conduits rectangulaires. Ils s'utilisent en apport d'air neuf ou en extraction. Ces caissons ne conviennent pas au transport d'air fortement pollué, de gaz agressifs ou explosifs. Ils sont compacts, fonctionnent silencieusement et peuvent être installés dans n'importe qu'elle position. La turbine s'enlève facilement pour l'entretien.

Turbine : pales incurvées vers l'arrière, plastique ou acier galvanisé.

Moteur : à rotor externe, entraînement direct avec protection thermique intégrée (PTO), roulements graissés à vie ne nécessitant pas d'entretien.

Enveloppe : tôle d'acier galvanisée.









Прямоугольные каналные вентиляторы для систем вентиляции и кондиционирования, устанавливаются в систему прямоугольных воздуховодов. Эксплуатируются в целях подачи и вытяжки воздуха. Не используются при транспортировке загрязнённого воздуха, агрессивных, взрывоопасных газов. Компактные, бесшумные, устанавливаются в любом положении, крыльчатка легко извлекается для чистки.

Крыльчатка: загнутые назад лопатки, пластмасса или оцинкованная сталь.

Двигатель: наружный ротор, прямая передача, встроенные термоконтакты двигателя, не требующие ухода подшипники с длительным сроком службы.

Корпус: оцинкованной жести.

## Accessories

Single phase speed controller	Three phase speed controller	Monophase speed controller	Flexible connection	Rectangular duct silencer	Filter cassette	Electrical duct heater
						
TGRV p. 84	TGRT p. 85	MTY p. 87	LJ/E LJ/PG p. 96	SKS p. 142	FDS p. 136	EKS p. 106

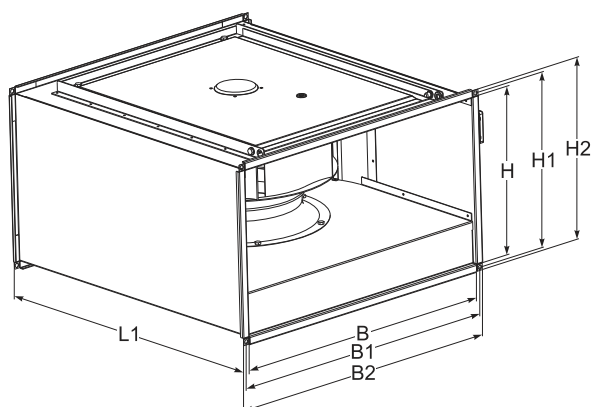

Type	Dimensions [mm]						
	B	B1	B2	H	H1	H2	L1
VKSB 300x150	300	320	340	150	170	190	400
VKSB 400x200	400	420	440	200	220	240	445
VKSB 500x250	500	520	540	250	270	290	530
VKSB 500x300	500	520	540	300	320	340	560
VKSB 600x300	600	620	640	300	320	340	640
VKSB 600x350	600	620	640	350	370	390	700
VKSB 700x400	700	720	740	400	420	440	780
VKSB 800x500	800	820	840	500	520	540	880
VKSB 1000x500	1000	1020	1040	500	520	540	980

Type	Accessories							
	TGRV	TGRT	MTY	LJ/E	LJ/PG	SKS	FDS	EKS
VKSB 300x150-2 L1	1,5	-	0,5	30x15	30x15	30-15	30-15	300x150
VKSB 400x200-2 L1	1,5	-	0,5	40x20	40x20	40-20	40-20	400x200
VKSB 400x200-2S L1	1,5	-	1,5	40x20	40x20	40-20	40-20	400x200
VKSB 500x250-2 L1	1,5	-	1,5	50x25	50x25	50-25	50-25	500x250
VKSB 500x250-2S L1	1,5	-	1,5	50x25	50x25	50-25	50-25	500x250
VKSB 500x300-2 L1	1,5	-	1,5	50x30	50x30	50-30	50-30	500x300
VKSB 500x300-2S L1	3	-	2,5	50x30	50x30	50-30	50-30	500x300
VKSB 500x300-4 L3	-	1	-	50x30	50x30	50-30	50-30	500x300
VKSB 600x300-4 L1	2	-	2,5	60x30	60x30	60-30	60-30	600x300
VKSB 600x300-4 L3	-	1	-	60x30	60x30	60-30	60-30	600x300
VKSB 600x350-4 L1	3	-	2,5	60x35	60x35	60-35	60-35	600x350
VKSB 600x350-4 L3	-	1	-	60x35	60x35	60-35	60-35	600x350
VKSB 700x400-4-L1	5	-	4	70x40	70x40	70-40	70-40	700x400
VKSB 700x400-4-L3	-	2	-	70x40	70x40	70-40	70-40	700x400
VKSB 800x500-4 L1	5	-	4	80x50	80x50	80-50	80-50	800x500
VKSB 800x500-4 L3	-	4	-	80x50	80x50	80-50	80-50	800x500
VKSB 1000x500-4 L3	-	5	-	100x50	100x50	100-50	100-50	1000x500

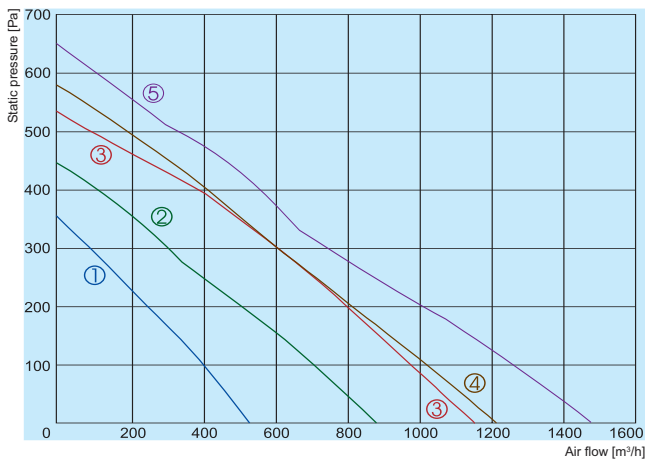

- ① — VKSB 300x150-2 L1
- ② — VKSB 400x200-2 L1
- ③ — VKSB 400x200-2S L1
- ④ — VKSB 500x250-2 L1
- ⑤ — VKSB 500x250-2S L1

		300x150-2 L1	400x200-2 L1	400x200-2S L1	500x250-2 L1	500x250-2S L1
Voltage/Frequency	[V/Hz]	230/50	230/50	230/50	230/50	230/50
Power consumption	[kW]	0,067	0,108	0,172	0,178	0,232
Current	[A]	0,29	0,47	0,76	0,78	1,01
Speed	[min <sup>-1</sup> ]	2467	2396	2458	2420	2401
Max. airflow	[m <sup>3</sup> /h]	558	899	1197	1250	1457
Max. air temperature	[°C]	50	40	60	60	50
Total sound power level at 1 m	[dBA]	77	81	85	87	87
Weight	[kg]	7,0	11,0	11,0	16,0	16,0
Wiring diagram		No. 4	No. 4	No. 4	No. 4	No. 4
Protection class:	motor	IP-44	IP-44	IP-44	IP-44	IP-44
	terminal box	IP-54	IP-54	IP-54	IP-54	IP-54

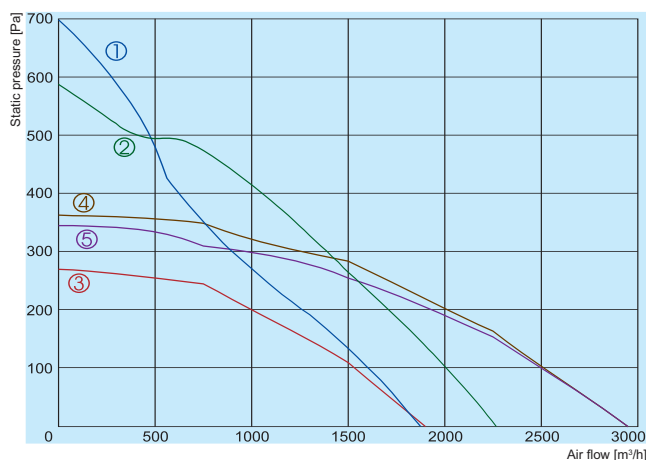

- ① VKSB 500x300-2 L1
- ② VKSB 500x300-2S L1
- ③ VKSB 500x300-4 L3
- ④ VKSB 600x300-4 L1
- ⑤ VKSB 600x300-4 L3

		500x300-2 L1	500x300-2S L1	500x300-4 L3	600x300-4 L1	600x300-4 L3
Voltage/Frequency	[V/Hz]	230/50	230/50	400/50	230/50	400/50
Power consumption	[kW]	0,313	0,388	0,15	0,31	0,27
Current	[A]	1,3	1,74	0,36	1,35	0,47
Speed	[min <sup>-1</sup> ]	2225	2750	1400	1370	1310
Max. airflow	[m <sup>3</sup> /h]	1920	2295	1880	2930	2930
Max. air temperature	[°C]	40	60	70	65	60
Total sound power level at 1 m	[dBA]	87	75	73	78	77
Weight	[kg]	17,0	17,0	18,0	19,0	21,0
Wiring diagram		No. 4	No.1	No. 3	No. 2	No. 3
Protection class:	motor	IP-44	IP-44	IP-54	IP-54	IP-54
	terminal box	IP-54	IP-54	IP-54	IP-54	IP-54

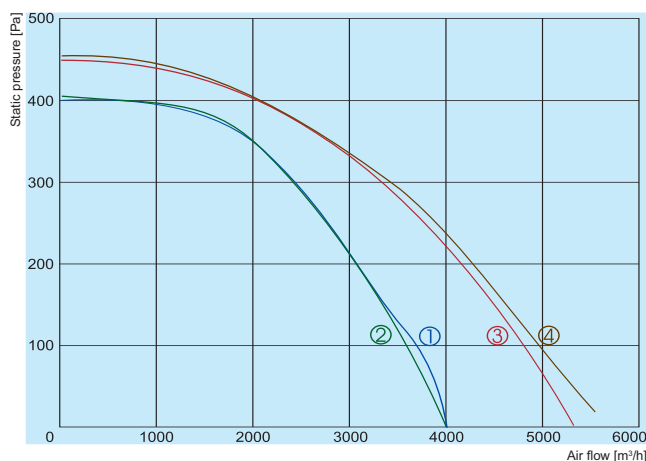

- ① VKSB 600x350-4 L1
- ② VKSB 600x350-4 L3
- ③ VKSB 700x400-4 L1
- ④ VKSB 700x400-4 L3

		600x350-4 L1	600x350-4 L3	700x400-4 L1	700x400-4 L3
Voltage/Frequency	[V/Hz]	230/50	400/50	230/50	400/50
Power consumption	[kW]	0,52	0,46	0,74	0,69
Current	[A]	2,2	0,85	3,2	1,3
Speed	[min <sup>-1</sup> ]	1360	1340	1280	1230
Max. airflow	[m <sup>3</sup> /h]	4010	4000	5330	5540
Max. air temperature	[°C]	40	55	60	40
Total sound power level at 1 m	[dBA]	77	77	83	83
Weight	[kg]	24,0	27,0	48,0	64,0
Wiring diagram		No. 2	No. 3	No. 2	No. 3
Protection class:	motor	IP-54	IP-54	IP-54	IP-54
	terminal box	IP-54	IP-54	IP-54	IP-54

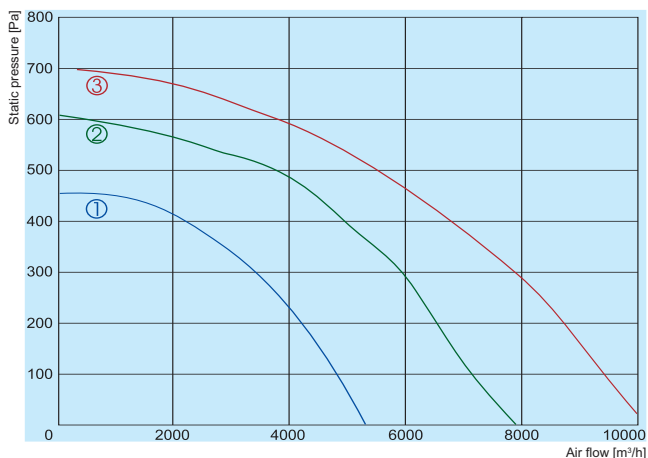

- ① VKSB 800x500-4 L1
- ② VKSB 800x500-4 L3
- ③ VKSB 1000x500-4 L3

		800x500-4 L1	800x500-4 L3	1000x500-4 L3
Voltage/Frequency	[V/Hz]	230/50	400/50	400/50
Power consumption	[kW]	0,74	1,25	1,8
Current	[A]	3,2	2,3	3,4
Speed	[min <sup>-1</sup> ]	1280	1340	1230
Max. airflow	[m³/h]	5300	7900	10000
Max. air temperature	[°C]	60	45	40
Total sound power level at 1 m	[dBA]	83	85	86
Weight	[kg]	56,0	69,0	89,0
Wiring diagram		No. 2	No. 3	No. 3
Protection class:	motor	IP-54	IP-54	IP-54
	terminal box	IP-54	IP-54	IP-54

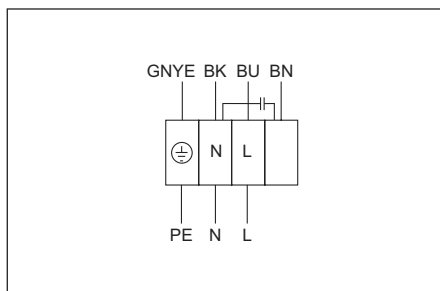

**Wiring diagram No. 1 (1~230V)**

GNYE - green-yellow  
 BK - black  
 BU - blue  
 BN - brown

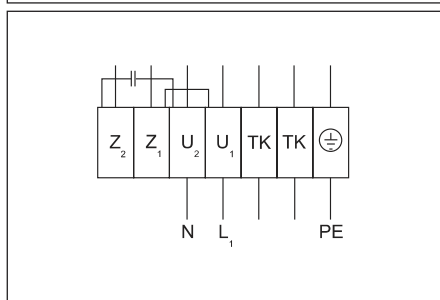

**Wiring diagram No. 2 (1~230V)**

U<sub>1</sub> - brown  
 U<sub>2</sub> - blue  
 Z<sub>1</sub> - black  
 Z<sub>2</sub> - orange  
 TK - white  
 PE - green-yellow

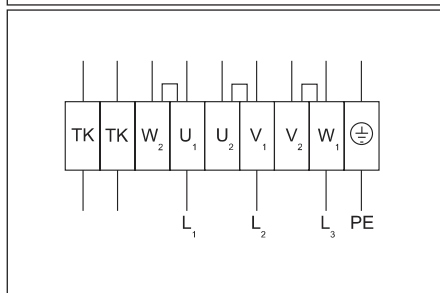

**Wiring diagram No. 3 (Δ - 3~230V)**

U<sub>1</sub> - brown  
 U<sub>2</sub> - red  
 V<sub>1</sub> - blue  
 V<sub>2</sub> - grey  
 W<sub>1</sub> - black  
 W<sub>2</sub> - orange  
 TK - white  
 PE - green-yellow

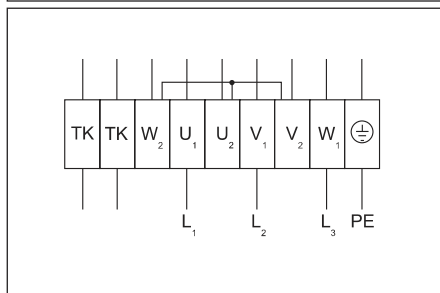

**Wiring diagram No. 3 (Y - 3~400V)**

U<sub>1</sub> - brown  
 U<sub>2</sub> - red  
 V<sub>1</sub> - blue  
 V<sub>2</sub> - grey  
 W<sub>1</sub> - black  
 W<sub>2</sub> - orange  
 TK - white  
 PE - green-yellow

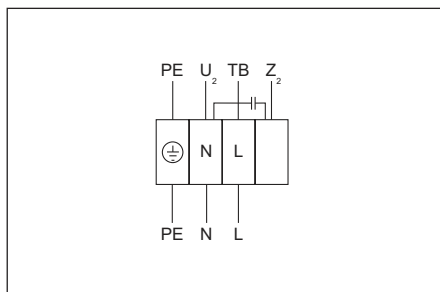

**Wiring diagram No. 4 (1~230V)**

U<sub>2</sub> - blue or grey  
 Z<sub>2</sub> - black  
 TB - brown  
 PE - green-yellow